

1101572

HEATING ELEMENT FAEMA E/98 2 GR W3750 V220/380

Date: 23-02-2025



Technical data

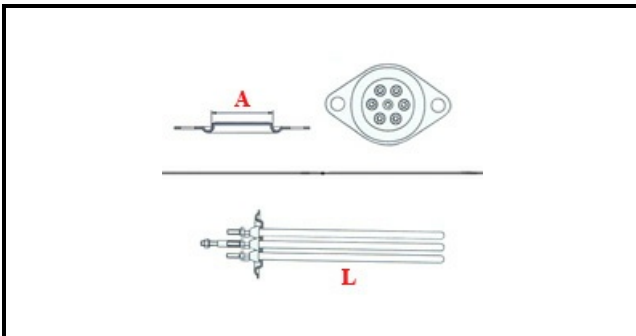

DEPTH MM	L=285mm
ELEMENTS	ELEMENTI/ELEMENTS=3
ROUND FLANGE	TONDA/ROUND FLANGE=42mm
DIAMETER mm	A=42mm
KILOWATT KW	KW=3,75
WATT	WATT=3750
THREE PHASE	TRIFASE/THREEPHASE
NUMBER OF POLES	POLI/POLES=6
NUMBER OF HOLES	FORI/HOLES=2
GASKET	2102130
IMMERSION HEATING ELEMENTS	IMMERSIONE/IMMERSION ELEMENTS