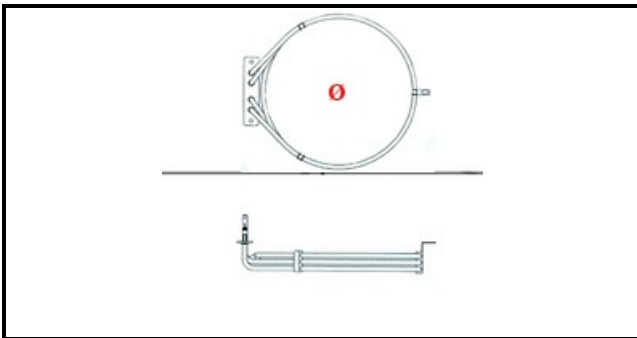

1101624

**OVEN HEATING ELEMENT 2000W X 2 230V**

Date: 29-01-2025

ORIGINAL  
**OSP**  
SPARE PARTS**Technical data**

DEPTH MM	L=240mm
ELEMENTS	ELEMENTI/ELEMENTS=2
SQUARE FLANGE	RETTANGOLARE/SQUARE FLANGE=100X22mm
EXTERNAL DIAMETER mm	Ø=200mm
KILOWATT KW	KW=4
WATT	WATT=4000
MONOPHASE	MONOFASE/MONOPHASE
NUMBER OF POLES	POLI/POLES=4
DRY HEATING ELEMENT	SECCO/DRY
INTERNAL DIAMETER mm	Ø=185mm

**Manufacturer code**

GARBIN INDUSTRIES SRL