

1101650

HEATING ELEMENT FOR PASTA COOKER 900

Date: 15-11-2024

ORIGINAL
OSP
SPARE PARTS

Technical data

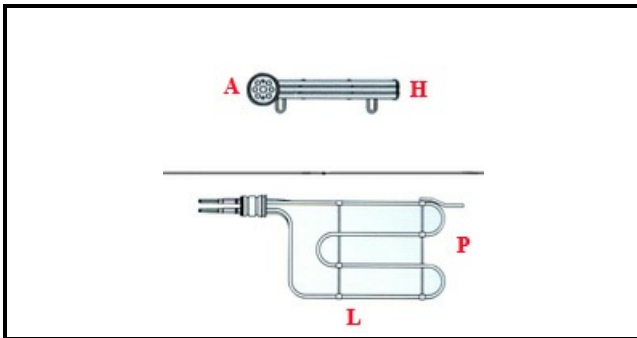

DEPTH MM	L=378mm
WIDTH MM	P=210mm
ELEMENTS	ELEMENTI/ELEMENTS=3
ROUND FLANGE	TONDA/ROUND FLANGE=63mm
DIAMETER mm	A=63mm
KILOWATT KW	KW=8,5
WATT	WATT=8500
THREE PHASE	TRIFASE/THREEPHASE
NUMBER OF POLES	POLI/POLES=6
IMMERSION HEATING ELEMENTS	IMMERSIONE/IMMERSION

Manufacturer code

SILKO ALI GROUP SRL A SOCIO UNICO

MARENO ALI GROUP SRL A SOCIO UNICO