

1101681

ROUND HEATING ELEMENT FOR OVEN 1550W 230V

Date: 23-11-2024



Technical data

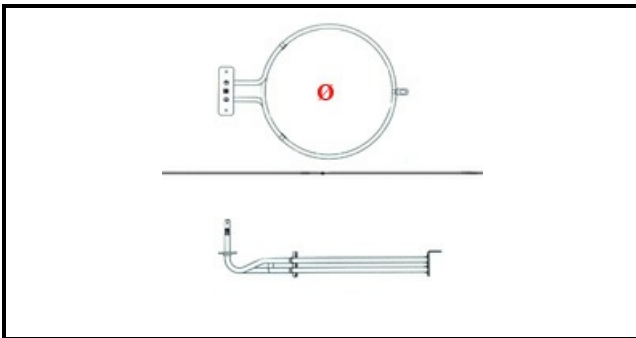

DEPTH MM	L=210mm
HEIGHT MM	H=28mm
ELEMENTS	ELEMENTI/ELEMENTS=1
SQUARE FLANGE	RETTANGOLARE/SQUARE FLANGE=70X22mm
EXTERNAL DIAMETER mm	Ø= 195 mm
KILOWATT KW	KW=1,55
WATT	WATT=1550
MONOPHASE	MONOFASE/MONOPHASE
NUMBER OF POLES	POLI/POLES=2
NUMBER OF HOLES	FORI/HOLES=2
DRY HEATING ELEMENT	SECCO/DRY
INTERNAL DIAMETER mm	Ø= 180 mm