

1101787

"HEATING ELEMENT; 230V 9000W"

Date: 23-02-2025



ORIGINAL
OSP
SPARE PARTS

Technical data

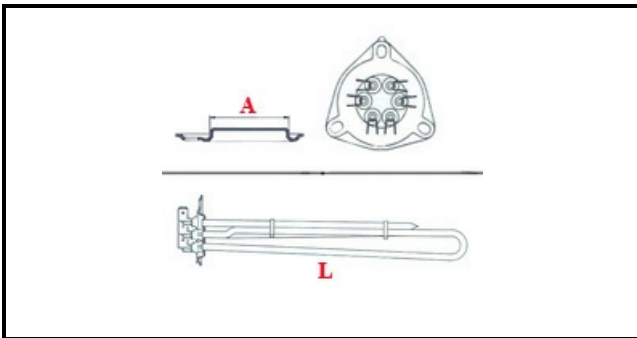

DEPTH MM	L=330mm
ELEMENTS	ELEMENTI/ELEMENTS=3
TRIANGULAR FLANGE	TRIANGOLARE/TRIANGULAR FLANGE=57mm
DIAMETER mm	A=57mm
KILOWATT KW	KW=9
WATT	WATT=9000
THREE PHASE	TRIFSAE/THREEPHASE
NUMBER OF POLES	POLI/POLES=6
NUMBER OF HOLES	FORI/HOLES=3
GASKET	2101033
IMMERSION HEATING ELEMENTS	IMMERSIONE/IMMERSION

Manufacturer code

ELECTROLUX PROFESSIONAL S.P.A.
ELECTROLUX PROFESSIONAL S.P.A.
ELECTROLUX PROFESSIONAL S.P.A.