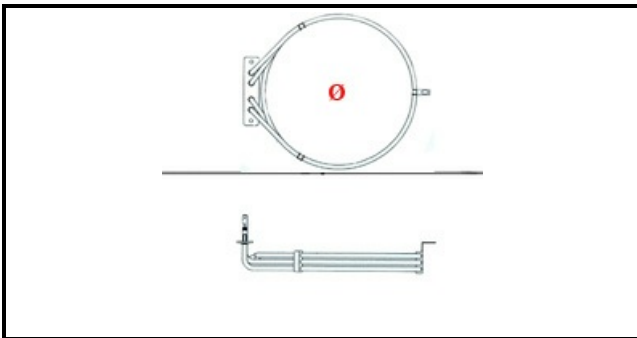

1101810

**HEATING ELEMENT 4000W**

Date: 22-11-2024

ORIGINAL  
**OSP**  
SPARE PARTS**Technical data**

DEPTH MM	L=270mm
ELEMENTS	ELEMENTI/ELEMENTS=2
SQUARE FLANGE	RETTANGOLARE/SQUARE FLANGE=100X22mm
EXTERNAL DIAMETER mm	Ø=200mm
KILOWATT KW	KW=4
WATT	WATT=4000
THREE PHASE	MONOFASE/MONOPHASE
NUMBER OF POLES	POLI/POLES=4
NUMBER OF HOLES	FORI/HOLES=2
DRY HEATING ELEMENT	SECCO/DRY
INTERNAL DIAMETER mm	Ø=180mm

**Manufacturer code**

GARBIN INDUSTRIES SRL