

1101914

## HEATING ELEMENT 7,2kW-230V

Date: 23-12-2024

ORIGINAL  
**OSP**  
SPARE PARTS

### Technical data

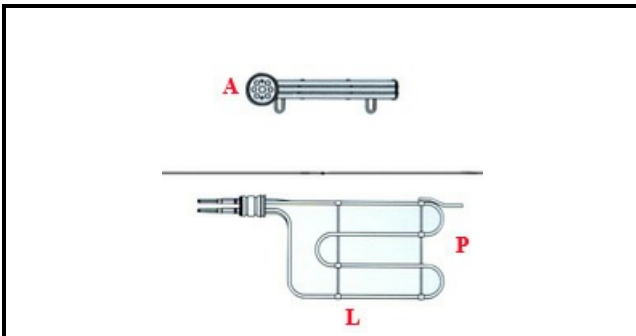

DEPTH MM	L=280mm
WIDTH MM	P=155mm
ELEMENTS	ELEMENTI/ELEMENTS=3
ROUND FLANGE	TONDA/ROUND FLANGE=53mm
DIAMETER mm	A=53mm
KILOWATT KW	KW=7,2
WATT	WATT=7200
THREE PHASE	TRIFASE/THREEPHASE
NUMBER OF POLES	POLI/POLES=6
IMMERSION HEATING ELEMENTS	IMMERSIONE/IMMERSION

### Manufacturer code

ANGELO PO GRANDI CUCINE SPA