

1101991

OVEN HEATING ELEMENT D.193MM WATT 2700 230V FLANGE70X22

Date: 23-12-2024



Technical data

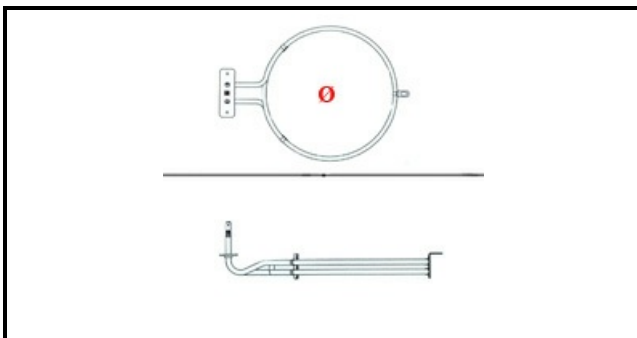

DEPTH MM	L=242mm
ELEMENTS	ELEMENTI/ELEMENTS=1
SQUARE FLANGE	RETTANGOLARE/SQUARE FLANGE=70X22mm
DIAMETER mm	Ø=193mm
KILOWATT KW	KW=2,7
WATT	WATT=2700
MONOPHASE	MONOFASE/MONOPHASE
NUMBER OF POLES	POLI/POLES=2
NUMBER OF HOLES	FORI/HOLES=2
DRY HEATING ELEMENT	SECCO/DRY