

1201027

# HEATING ELEMENT PASTA COOKER 5,6KW 230V 700

Date: 11-04-2025



ORIGINAL  
**OSP**  
SPARE PARTS

## Technical data

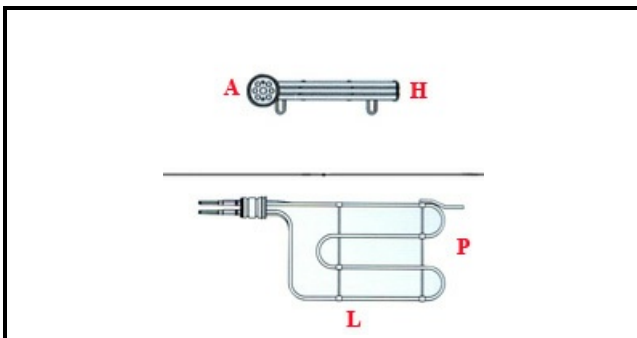

DEPTH MM	L=255mm
WIDTH MM	P=210mm
ELEMENTS	ELEMENTI/ELEMENTS=3
ROUND FLANGE	TONDA/ROUND FLANGE=63mm
DIAMETER mm	A=63mm
KILOWATT KW	KW=5,6
WATT	WATT=5600
MONOPHASE	MONOFASE/MONOPHASE
GAS THREAD	54X1,5
NUMBER OF POLES	POLI/POLES=6
IMMERSION HEATING ELEMENTS	IMMERSIONE/IMMERSION
EXTERNAL DIAMETER mm	Ø est=63mm
INTERNAL DIAMETER mm	Ø int=54mm