

1201057

HEATING ELEMENT 3000W/3 INOX FLANGE

Date: 29-04-2025



ORIGINAL
OSP
SPARE PARTS

Technical data

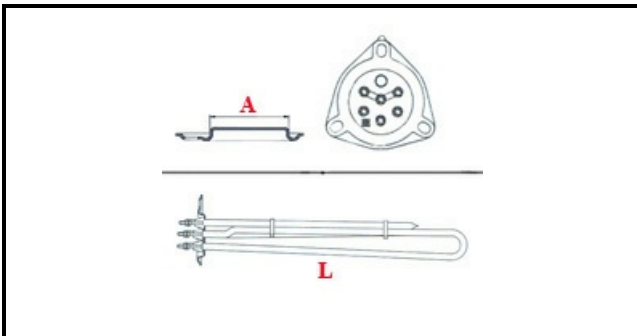

DEPTH MM	L=180mm
WIDTH MM	A=57mm
ELEMENTS	ELEMENTI/ELEMENTS=3
TRIANGULAR FLANGE	TRIANGOLARE/TRIANGULAR FLANGE=57mm
DIAMETER mm	A=57mm
KILOWATT KW	KW=3
WATT	WATT=3000
THREE PHASE	TRIFASE/THREEPHASE
NUMBER OF POLES	POLI/POLES=3
NUMBER OF HOLES	FORI/HOLES=3
GASKET	GUARNIZIONE/GASKET=210
IMMERSION HEATING ELEMENTS	IMMERSIONE/IMMERSION

Manufacturer code

LAMBER SRL