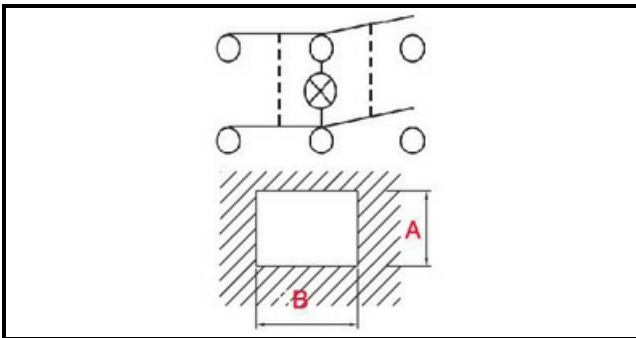

1105462

LED SWITCH

Date: 22-12-2024

ORIGINAL
OSP
SPARE PARTS**Technical data**

DEPTH MM	B=20mm
WIDTH MM	A=13mm
NUMBER OF POLES	POLI/POLES=4
NUMBER OF POSITIONS	0-1
COLOR	VERDE/GREEN
VOLT	250V

Manufacturer code

SCOTSMAN ICE Srl.

SCOTSMAN ICE Srl.