

1106352

# TANK THERMOSTAT 50° SINGLE PHASE KIT DRT141

Date: 23-02-2025

ORIGINAL  
**OSP**  
SPARE PARTS

## Technical data

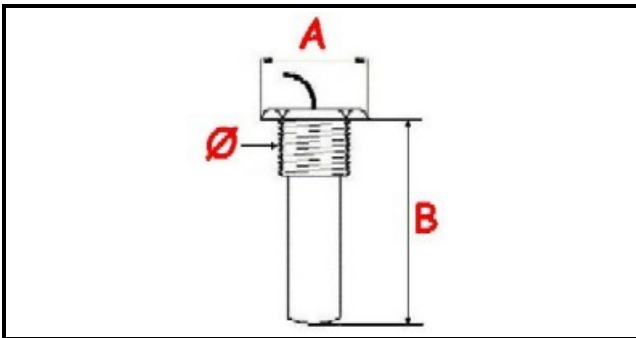

|                       |                    |
|-----------------------|--------------------|
| MONOPHASE             | MONOFASE/MONOPHASE |
| GAS THREAD            | Ø=14mm             |
| NUMBER OF POLES       | POLI/POLES=3       |
| MINIMUM TEMPERATURE ° | T min=0°           |
| MAXIMUM TEMPERATURE ° | T max=50°          |
| WIRE mm               | L=600mm            |
| PROBE DIAMETER MM     | A=22mm             |
| PROBE LENGHT MM       | B=32mm             |

## Manufacturer code

ELETTOBAR EUROTEC SRL

ELETTOBAR EUROTEC SRL