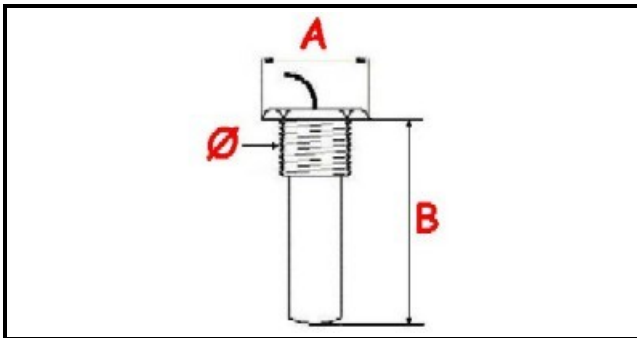

1106713

**THERMOSTAT 338°C THREEPHASE SAFETY - SENSOR Ø 10X50 mm  
CAPILLARY 800mm**

Date: 23-01-2025

ORIGINAL  
**OSP**  
SPARE PARTS**Technical data**

THREE PHASE	TRIFASE/THREE PHASE
GAS THREAD	Ø=10mm
NUMBER OF POLES	POLI/POLES=5
MAXIMUM TEMPERATURE °	T max=338°
WIRE mm	L=900mm
PROBE LENGHT MM	B=53mm

**Manufacturer code**

ELECTROLUX PROFESSIONAL S.P.A.

E.G.O. ELEKTRO GERATE AG