

1201101

RESISTENZA .COR.ROT.CP70 7800W 3-230V

Data: 06-04-2025



ORIGINAL
OSP
SPARE PARTS

Dati tecnici

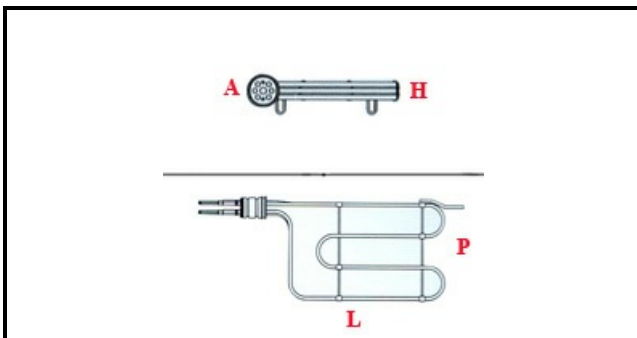

LUNGHEZZA MM	L=290mm
LARGHEZZA MM	P=190mm
NR ELEMENTI	ELEMENTI/ELEMENTS=3
FLANGIA TONDA	TONDA/ROUND FLANGE=60mm
DIAMETRO mm	A=60mm
KILOWATT KW	KW=7,8
WATT	WATT=7800
MONOFASE	MONOFASE/MONOPHASE
NUMERO POLI	POLI/POLES=6
RESISTENZE PER IMMERSIONE	IMMERSIONE/IMMERSION
FLANGIA FILETTATA	2"

Codici produttore

LOTUS SPA
LOTUS SPA