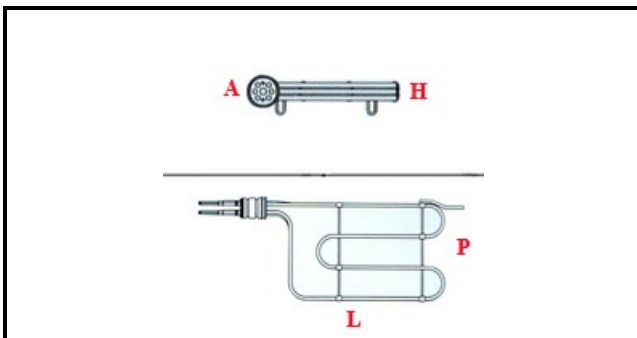

1201034

RESISTENZA COR.ROTANTE FS60 3300W 1-230V (S)

Data: 23-12-2024

ORIGINAL
OSP
SPARE PARTS**Dati tecnici**

LUNGHEZZA MM	L=300mm
LARGHEZZA MM	P=170mm
ALTEZZA MM	H=65mm
NR ELEMENTI	ELEMENTI/ELEMENTS=1
FLANGIA TONDA	TONDA/ROUND FLANGE=65mm
DIAMETRO mm	A=65mm
KILOWATT KW	KW=3,3
WATT	WATT=3300
MONOFASE	MONOFASE/MONOPHASE
NUMERO POLI	POLI/POLES=2
GUARNIZIONE	2101485
RESISTENZE PER IMMERSIONE	IMMERSIONE/IMMERSION
DIAMETRO ESTERNO mm	A=65mm

Codici produttore

LOTUS SPA