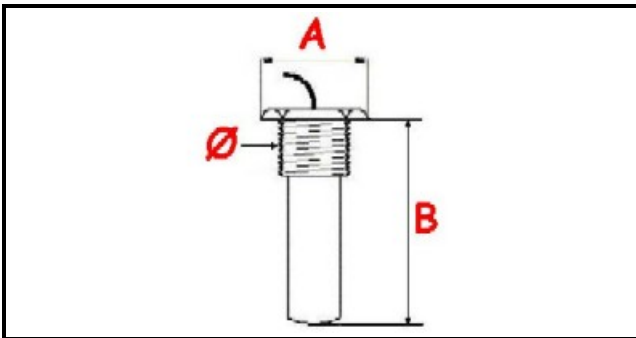

1106891

TERMOSTATO TRIPOLARE SIC. 220°C-18

Data: 23-01-2025

ORIGINAL
OSP
SPARE PARTS**Dati tecnici**

TRIFASE	TRIFASE/THREEPHASE
FILETTO MA	Ø=14mm
NUMERO POLI	POLI/POLES=6
TEMPERATURA MASSIMA °	Tmax=220°C
CAPILLARE mm	L=1450mm
SENSORE DIAMETRO MM	A=10mm

Codici produttore

ELFRAMO SPA

E.G.O. ELEKTRO GERATE AG