

3111154

RACCORDO SCARICO TROPPOPIENO KL-KD3

Data: 22-12-2024

ORIGINAL
OSP
SPARE PARTS

Dati tecnici

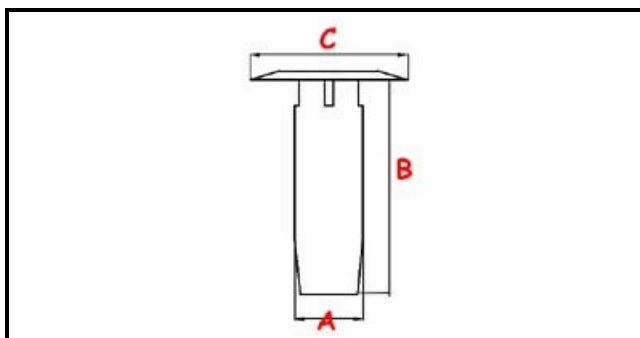

ALTEZZA MM	B=120mm
MATERIALE	PLASTICA/PLASTIC
DIAMETRO SUPERIORE	C=45mm
DIAMETRO INFERIORE	A=18mm

Codici produttore

MIGEL S.R.L.