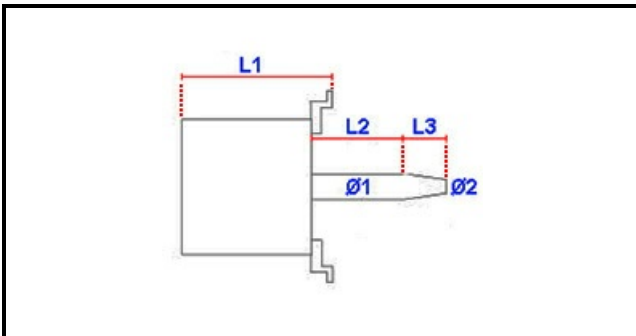

1103706

**MOTORE 3042D2350 KW0,55/0,15 230V**

Data: 22-12-2024

**Dati tecnici**

LUNGHEZZA MOTORE mm	L1=150mm
LUNGHEZZA ALBERO 1 mm	L2=54mm
LUNGHEZZA ALBERO 2 mm	L3=48mm
DIAMETRO ALBERO mm	Ø1=24mm
HP- CAVALLI	HP=0,75
KILOWATT KW	KW=0,55/0,15
MONOFASE	230V
DIAMETRO ALBERO 2 mm	Ø2=20mm

**Codici produttore**

NIDEC FIR INTERNATIONAL SRL