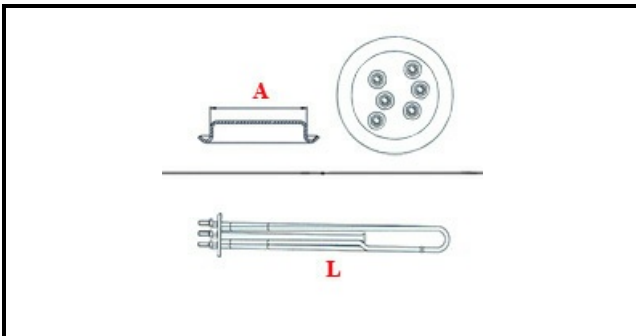

1101013

RESISTENZA 4500W ATA

Data: 22-02-2025

ORIGINAL
OSP
SPARE PARTS**Dati tecnici**

LUNGHEZZA MM	L=370mm
NR ELEMENTI	ELEMENTI/ELEMENTS=3
FLANGIA TONDA	FLANGIA TONDA/ROUND FLANGE=47mm
DIAMETRO mm	A=48mm
KILOWATT KW	KW=4,5
WATT	W=4500
TRIFASE	TRIFASE/THREEPHASE
NUMERO POLI	POLI/POLES=6
GUARNIZIONE	2101032
RESISTENZE PER IMMERSIONE	IMMERSIONE/IMMERSION

Codici produttore

A.T.A. SRL