

1101081

# RESISTENZA ZANUSSI 058995 17000W

Data: 05-04-2025



ORIGINAL  
**OSP**  
SPARE PARTS

## Dati tecnici

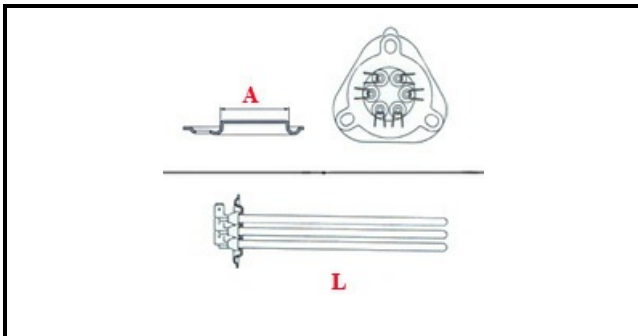

LUNGHEZZA MM	L=575mm
NR ELEMENTI	ELEMENTI/ELEMENTS=3
FLANGIA TRIANGOLARE	TRIANGOLARE/TRIANGULAR FLANGE=48mm
DIAMETRO mm	A=48mm
KILOWATT KW	KW=17
WATT	WATT=17000
TRIFASE	TRIFASE/THREEPHASE
NUMERO POLI	POLI/POLES=6
FORI NUMERO	FORI/HOLES=3
GUARNIZIONE	2101032
RESISTENZE PER IMMERSIONE	IMMERSIONE/IMMERSION

## Codici produttore

ELECTROLUX PROFESSIONAL S.P.A.