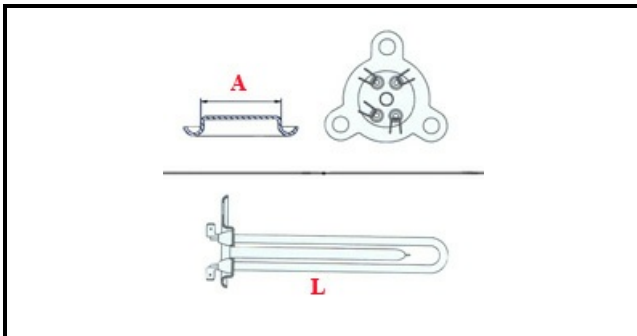

1101120

**RESISTENZA 3000W 230V D.38 2 EL.**

Data: 15-11-2024

**Dati tecnici**

LUNGHEZZA MM	L=285mm
NR ELEMENTI	ELEMENTI/ELEMENTS=2
FLANGIA TRIANGOLARE	TRIANGOLARE/TRIANGULAR FLANGE=38mm
DIAMETRO mm	A=38mm
KILOWATT KW	KW=3
WATT	WATT=3000
MONOFASE	MONOFASE/MONOPHASE
NUMERO POLI	POLI/POLES=4
FORI NUMERO	FORI/HOLES=3
GUARNIZIONE	2101031
RESISTENZE PER IMMERSIONE	IMMERSIONE/IMMERSION