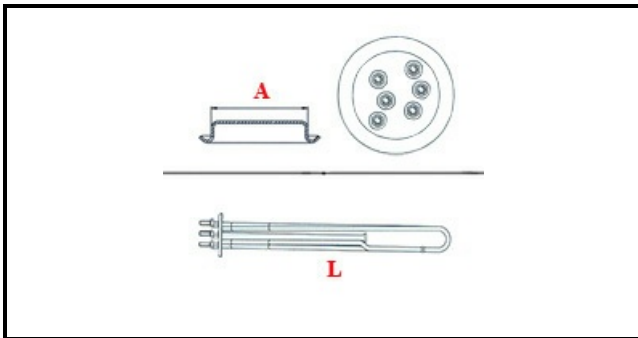

1101223

RESISTENZA 12000/13070W 230/240V

Data: 24-11-2024

**Dati tecnici**

LUNGHEZZA MM	L=470mm
NR ELEMENTI	ELEMENTI/ELEMENTS=3
FLANGIA TONDA	TONDA/ROUND FLANGE=57mm
DIAMETRO mm	A=57mm
KILOWATT KW	KW=12
WATT	WATT=12000
TRIFASE	TRIFASE/THREEPHASE
NUMERO POLI	POLI/POLES=6
GUARNIZIONE	2101033
RESISTENZE PER IMMERSIONE	IMMERSIONE/IMMERSION