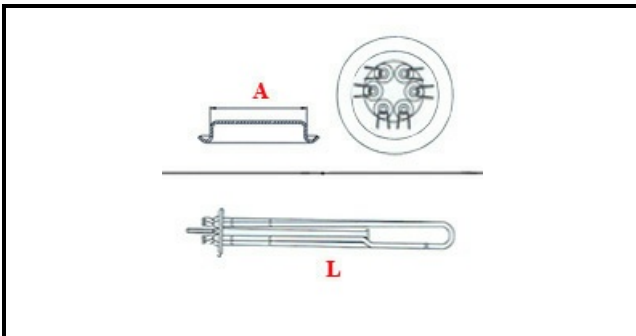

1101292

RESISTENZA W3000 3L FL58

Data: 15-11-2024

ORIGINAL
OSP
SPARE PARTS**Dati tecnici**

LUNGHEZZA MM	L=270mm
NR ELEMENTI	ELEMENTI/ELEMENTS=3
FLANGIA TONDA	TONDA/ROUND FLANGE=47mm
DIAMETRO mm	A=47mm
KILOWATT KW	KW=3
WATT	WATT=3000
TRIFASE	TRIFASE/THREEPHASE
NUMERO POLI	POLI/POLES=6
GUARNIZIONE	2101032
RESISTENZE PER IMMERSIONE	IMMERSIONE/IMMERSION

Codici produttore

DIHR - ALI GROUP SRL A SOCIO UNICO

A.T.A. SRL