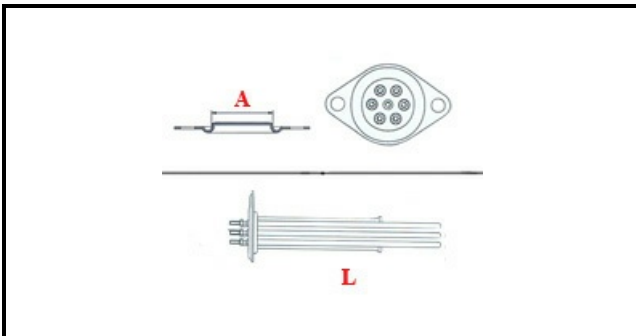

1101378

**RESISTENZA 4500W 230V**

Data: 22-12-2024

ORIGINAL  
**OSP**  
SPARE PARTS**Dati tecnici**

LUNGHEZZA MM	L=350mm
NR ELEMENTI	ELEMENTI/ELEMENTS=3
FLANGIA TONDA	TONDA/ROUND FLANGE=43mm
DIAMETRO mm	A=43mm
KILOWATT KW	KW=4,5
WATT	WATT=4500
TRIFASE	TRIFASE/THREEPHASE
NUMERO POLI	POLI/POLES=6
FORI NUMERO	FORI/HOLES=2
GUARNIZIONE	2102935
RESISTENZE PER IMMERSIONE	IMMERSIONE/IMMERSION

**Codici produttore**

MAGISTER SISTEMA CAFFE' SRL