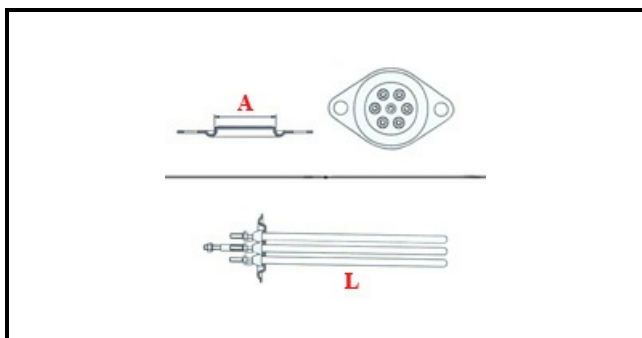

1101452

RESISTENZA 2 GR. 6P 4500W 230/380V

Data: 22-12-2024

ORIGINAL
OSP
SPARE PARTS**Dati tecnici**

NR ELEMENTI	ELEMENTI/ELEMENTS=3
FLANGIA TONDA	TONDA/ROUND FLANGE=42mm
DIAMETRO mm	A=42mm
KILOWATT KW	KW=4,5
WATT	WATT=4500
TRIFASE	TRIFASE/THREEPHASE
NUMERO POLI	POLI/POLES=6
FORI NUMERO	FORI/HOLES=2
GUARNIZIONE	2102130
RESISTENZE PER IMMERSIONE	IMMERSIONE/IMMERSION

Codici produttore

CMA MACCHINE PER CAFFE' SRL