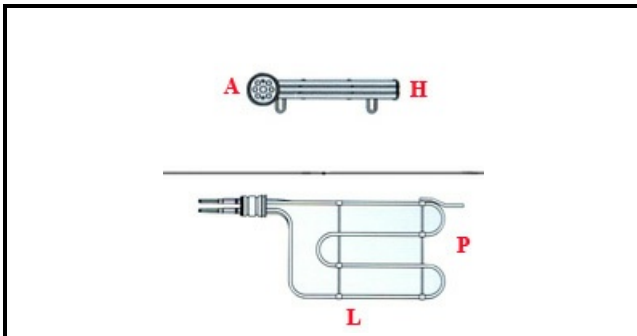

1101650

ASSIEME RESISTENZA CUOCIPASTA 900

Data: 27-02-2025

ORIGINAL
OSP
SPARE PARTS**Dati tecnici**

LUNGHEZZA MM	L=378mm
LARGHEZZA MM	P=210mm
NR ELEMENTI	ELEMENTI/ELEMENTS=3
FLANGIA TONDA	TONDA/ROUND FLANGE=63mm
DIAMETRO mm	A=63mm
KILOWATT KW	KW=8,5
WATT	WATT=8500
TRIFASE	TRIFASE/THREEPHASE
NUMERO POLI	POLI/POLES=6
RESISTENZE PER IMMERSIONE	IMMERSIONE/IMMERSION

Codici produttore

SILKO ALI GROUP SRL A SOCIO UNICO

MARENO ALI GROUP SRL A SOCIO UNICO