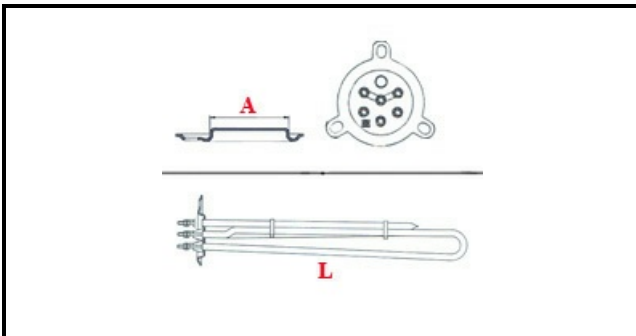

1101673

RESISTENZA 230V 14000W - C/FLANGIA BOILER 7 FORI

Data: 15-11-2024

ORIGINAL
OSP
SPARE PARTS**Dati tecnici**

LUNGHEZZA MM	L=480mm
NR ELEMENTI	ELEMENTI/ELEMENTS=3
FLANGIA TRIANGOLARE	TRIANGOLARE/TRIANGULAR FLANGE=62mm
DIAMETRO mm	A=62mm
KILOWATT KW	KW=14
WATT	WATT=14000
TRIFASE	TRIFASE/THREEPHASE
NUMERO POLI	POLI/POLES=6
FORI NUMERO	FORI/HOLES=3
GUARNIZIONE	2101058
RESISTENZE PER IMMERSIONE	IMMERSIONE/IMMERSION

Codici produttore

ARISTARCO / KASTEL S.P.A.
KRUPPS S.R.L.
ARISTARCO / KASTEL S.P.A.