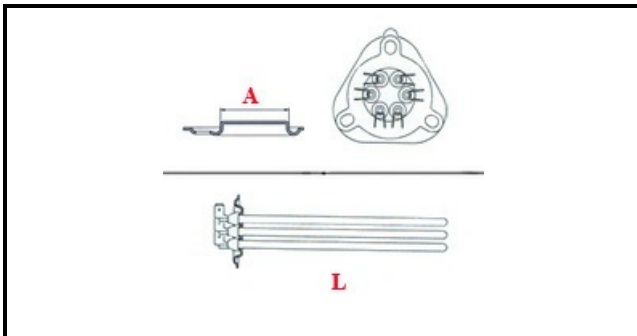

1101771

"RESISTENZA; 230V 4500W"

Data: 23-02-2025

ORIGINAL
OSP
SPARE PARTS**Dati tecnici**

LUNGHEZZA MM	L=260mm
NR ELEMENTI	ELEMENTI/ELEMENTS=3
FLANGIA TRIANGOLARE	TRIANGOLARE/TRIANGULAR FLANGE=47mm
DIAMETRO mm	A=47mm
KILOWATT KW	KW=4,5
WATT	WATT=4500
TRIFASE	TRIFASE/THREEPHASE
NUMERO POLI	POLI/POLES=6
FORI NUMERO	FORI/HOLES=3
GUARNIZIONE	2101032
RESISTENZE PER IMMERSIONE	IMMERSIONE/IMMERSION

Codici produttore

ELECTROLUX PROFESSIONAL S.P.A.

ELECTROLUX PROFESSIONAL S.P.A.