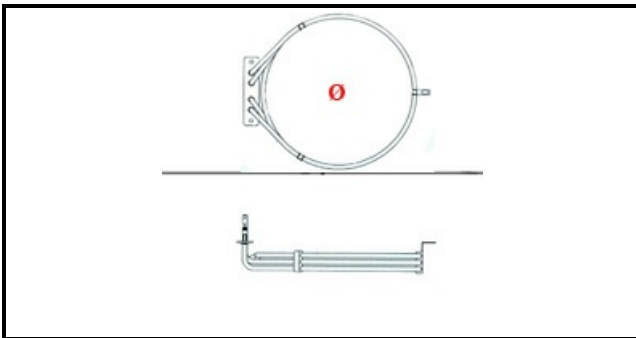

1101810

RESISTENZA 4000W

Data: 23-01-2025

ORIGINAL
OSP
SPARE PARTS**Dati tecnici**

LUNGHEZZA MM	L=270mm
NR ELEMENTI	ELEMENTI/ELEMENTS=2
FLANGIA RETTANGOLARE/QUADRA	RETTANGOLARE/SQUARE FLANGE=100X22mm
DIAMETRO ESTERNO mm	Ø=200mm
KILOWATT KW	KW=4
WATT	WATT=4000
TRIFASE	MONOFASE/MONOPHASE
NUMERO POLI	POLI/POLES=4
FORI NUMERO	FORI/HOLES=2
RESISTENZE A SECCO	SECCO/DRY
DIAMETRO INTERNO mm	Ø=180mm

Codici produttore

GARBIN INDUSTRIES SRL