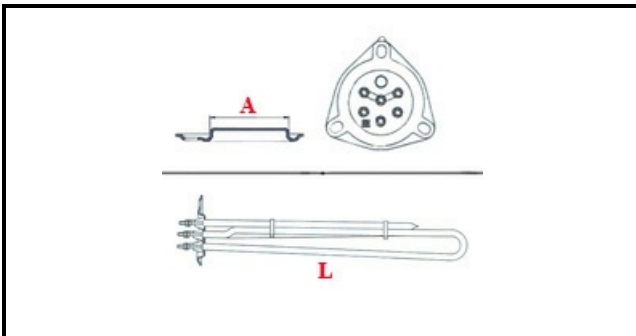

1101828

**RESISTENZA 7500W 230V - 9000W 256V 380V**

Data: 22-01-2025

**Dati tecnici**

LUNGHEZZA MM	L=410mm
NR ELEMENTI	ELEMENTI/ELEMENTS=3
FLANGIA TRIANGOLARE	TRIANGOLARE/TRIANGULAR FLANGE=57mm
DIAMETRO mm	A=57mm
KILOWATT KW	KW=7,5
WATT	WATT=7500
TRIFASE	TRIFASE/THREEPHASE
NUMERO POLI	POLI/POLES=6
FORI NUMERO	FORI/HOLES=3
GUARNIZIONE	2101033
RESISTENZE PER IMMERSIONE	IMMERSIONE/IMMERSION