

1101834

RESISTENZA CUOCIPASTA 3,8KW 230V

Data: 08-04-2025



ORIGINAL
OSP
SPARE PARTS

Dati tecnici

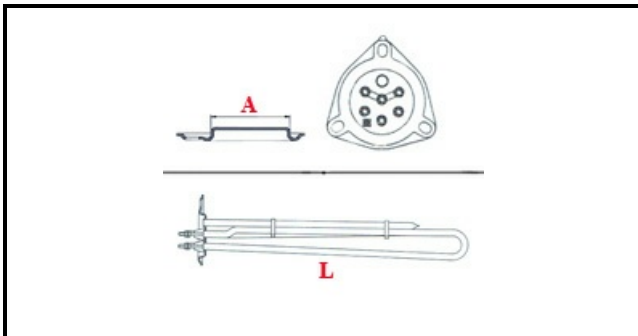

LUNGHEZZA MM	L=250mm
NR ELEMENTI	ELEMENTI/ELEMENTS=3
FLANGIA TRIANGOLARE	TRIANGOLARE/TRIANGULAR FLANGE=57mm
DIAMETRO mm	A=57mm
KILOWATT KW	KW=3,8
WATT	WATT=3800
TRIFASE	TRIFASE/THREEPHASE
NUMERO POLI	POLI/POLES=3
FORI NUMERO	FORI/HOLES=3
GUARNIZIONE	2101033
RESISTENZE PER IMMERSIONE	IMMERSIONE/IMMERSION

Codici produttore

MODULAR PROFESSIONAL SRL