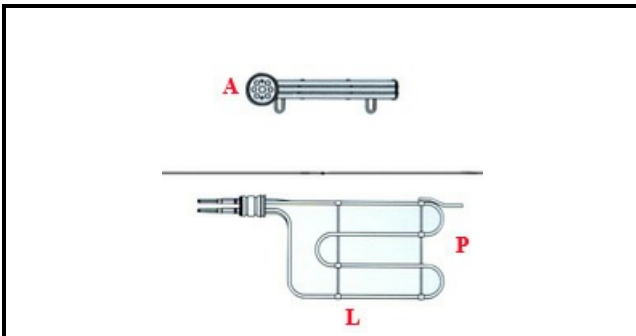

1101914

RESISTENZA 7,2kW-230V

Data: 14-03-2025

ORIGINAL
OSP
SPARE PARTS**Dati tecnici**

LUNGHEZZA MM	L=280mm
LARGHEZZA MM	P=155mm
NR ELEMENTI	ELEMENTI/ELEMENTS=3
FLANGIA TONDA	TONDA/ROUND FLANGE=53mm
DIAMETRO mm	A=53mm
KILOWATT KW	KW=7,2
WATT	WATT=7200
TRIFASE	TRIFASE/THREEPHASE
NUMERO POLI	POLI/POLES=6
RESISTENZE PER IMMERSIONE	IMMERSIONE/IMMERSION

Codici produttore

ANGELO PO GRANDI CUCINE SPA