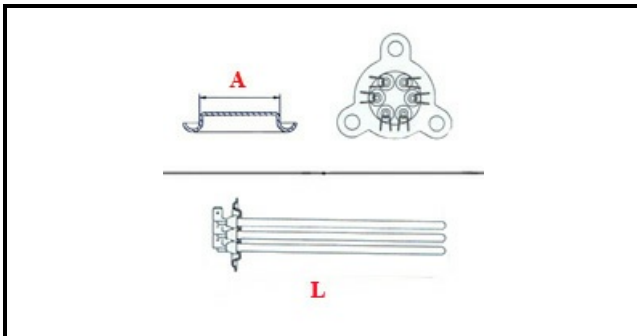

1101926

RESISTENZA VASCA/BOILER 9KW 230/380V

Data: 15-11-2024

ORIGINAL
OSP
SPARE PARTS**Dati tecnici**

LUNGHEZZA MM	L=447mm
NR ELEMENTI	ELEMENTI/ELEMENTS=3
FLANGIA TRIANGOLARE	TRIANGOLARE/TRIANGULAR FLANGE=62mm
DIAMETRO mm	A=62mm
KILOWATT KW	KW=9
WATT	WATT=9000
TRIFASE	TRIFASE/THREEPHASE
NUMERO POLI	POLI/POLES=6
FORI NUMERO	FORI/HOLES=3
GUARNIZIONE	2101058
RESISTENZE PER IMMERSIONE	IMMERISONE/IMMERSION

Codici produttore

ARISTARCO / KASTEL S.P.A.

ARISTARCO / KASTEL S.P.A.