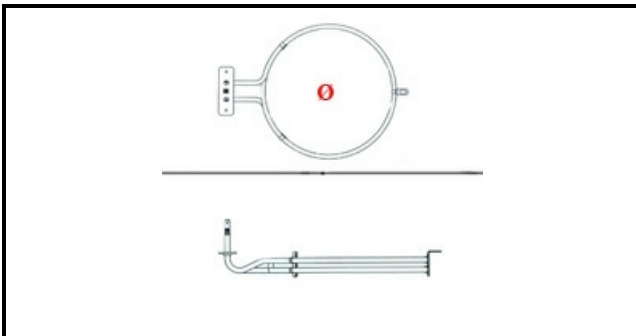

1101991

RESISTENZA CIRCOLARE FORNO D.193MM WATT 2700 230V 70X22

Data: 23-02-2025

**Dati tecnici**

LUNGHEZZA MM	L=242mm
NR ELEMENTI	ELEMENTI/ELEMENTS=1
FLANGIA RETTANGOLARE/QUADRA	RETTANGOLARE/SQUARE FLANGE=70X22mm
DIAMETRO mm	Ø=193mm
KILOWATT KW	KW=2,7
WATT	WATT=2700
MONOFASE	MONOFASE/MONOPHASE
NUMERO POLI	POLI/POLES=2
FORI NUMERO	FORI/HOLES=2
RESISTENZE A SECCO	SECCO/DRY