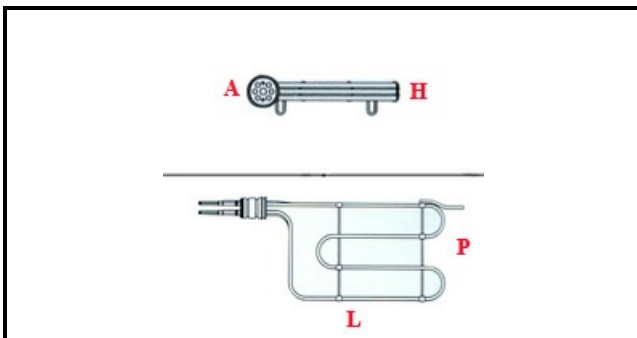

1201027

RESISTENZA [C] 5,6KW 230V CUOCIPASTA 700

Data: 01-11-2024

ORIGINAL
OSP
SPARE PARTS**Dati tecnici**

LUNGHEZZA MM	L=255mm
LARGHEZZA MM	P=210mm
NR ELEMENTI	ELEMENTI/ELEMENTS=3
FLANGIA TONDA	TONDA/ROUND FLANGE=63mm
DIAMETRO mm	A=63mm
KILOWATT KW	KW=5,6
WATT	WATT=5600
MONOFASE	MONOFASE/MONOPHASE
FILETTO GAS	54X1,5
NUMERO POLI	POLI/POLES=6
RESISTENZE PER IMMERSIONE	IMMERSIONE/IMMERSION
DIAMETRO ESTERNO mm	Ø est=63mm
DIAMETRO INTERNO mm	Ø int=54mm