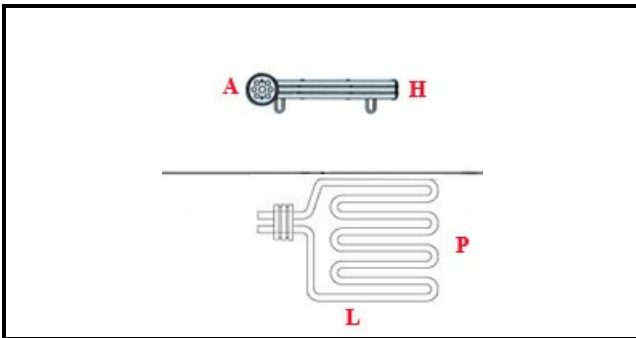

1201042

**RES.COR.ROT.F18 15900W 3-230V (T)**

Data: 23-01-2025

ORIGINAL  
**OSP**  
SPARE PARTS**Dati tecnici**

NR ELEMENTI	ELEMENTI/ELEMENTS=3
KILOWATT KW	KW=15,9
WATT	WATT=15900
TRIFASE	TRIFASE/THREEPHASE
NUMERO POLI	POLI/POLES=6
RESISTENZE PER IMMERSIONE	IMMERSIONE/IMMERSION

**Codici produttore**

LOTUS SPA