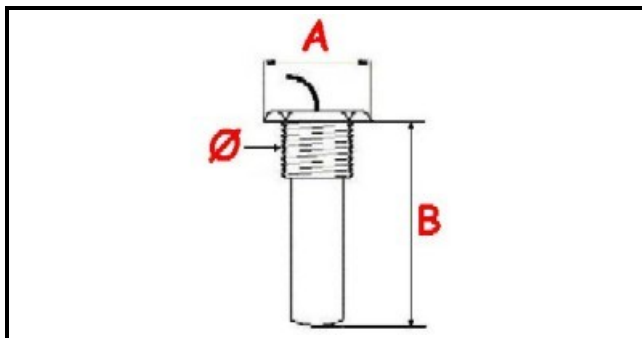

1106012

**TERMOSTATO FISSO 50° MONOFASE SENSORE Ø 17X48 mm
CAPILLARE 600mm**

Data: 23-02-2025

**Dati tecnici**

MONOFASE	MONOFASE/MONOPHASE
FILETTO GAS	Ø=17mm
NUMERO POLI	POLI/POLES=3
TEMPERATURA MASSIMA °	T max=50°
SENSORE DIAMETRO MM	A=21mm
SENSORE LUNGHEZZA MM	B=48mm
GUARNIZIONE	2102214
DADO	1141248

Codici produttore

SILANOS SRL