

1106048

# TERMOSTATO REGOLAZIONE A BOTTONE 70-170°C MONOFASE - SENSORE Ø14X25mm CAPILLARE 800mm

Data: 22-12-2024



## Dati tecnici

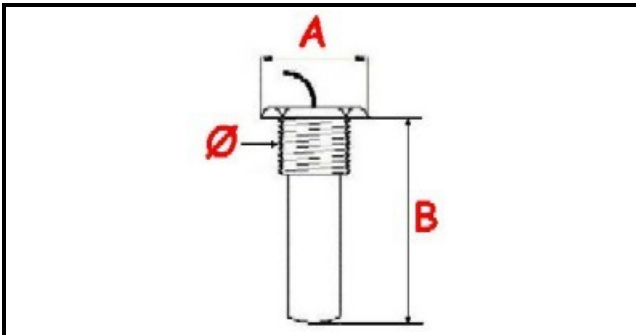

MONOFASE	MONOFASE/MONOPHASE
FILETTO GAS	Ø=14mm
NUMERO POLI	POLI/POLES=2
TEMPERATURA MINIMA °	T min=70°
TEMPERATURA MASSIMA °	T max=170°
CAPILLARE mm	L=800mm
SENSORE DIAMETRO MM	B=25mm
SENSORE LUNGHEZZA MM	A=25mm
ALBERO mm	ALBERO/SHAFT=4X6mm