

1106175

TERMOSTATO 135° TRIFASE SICUREZZA A.PO - SENSORE Ø 14X27,5mm CAPILLARE 1000mm

Data: 22-12-2024

ORIGINAL
OSP
SPARE PARTS

Dati tecnici

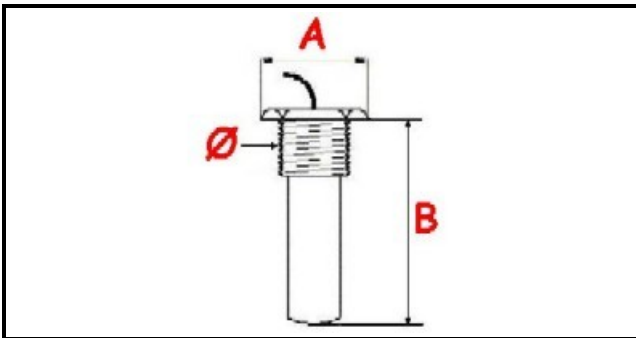

TRIFASE	TRIFASE/THREE PHASE
FILETTO GAS	Ø=14mm
NUMERO POLI	POLI/POLES=6
TEMPERATURA MASSIMA °	T max=135°
CAPILLARE mm	L=1000mm
SENSORE LUNGHEZZA MM	B=27,5mm

Codici produttore

ANGELO PO GRANDI CUCINE SPA
ANGELO PO GRANDI CUCINE SPA
E.G.O. ELEKTRO GERATE AG