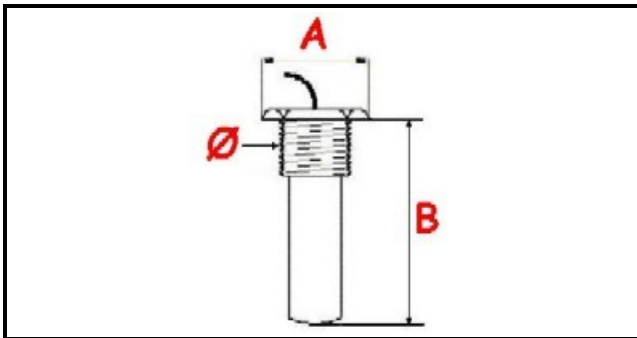

1106713

**TERMOSTATO 338°C TRIFASE SICUREZZA - SENSORE Ø 10X53 mm
CAPILLARE 900mm**

Data: 24-02-2025

ORIGINAL
OSP
SPARE PARTS**Dati tecnici**

TRIFASE	TRIFASE/THREE PHASE
FILETTO GAS	Ø=10mm
NUMERO POLI	POLI/POLES=5
TEMPERATURA MASSIMA °	T max=338°
CAPILLARE mm	L=900mm
SENSORE LUNGHEZZA MM	B=53mm

Codici produttore

ELECTROLUX PROFESSIONAL S.P.A.

E.G.O. ELEKTRO GERATE AG