

1101261

RESISTENZA 6000W/400V A.PO

Data: 18-04-2025



ORIGINAL
OSP
SPARE PARTS

Dati tecnici

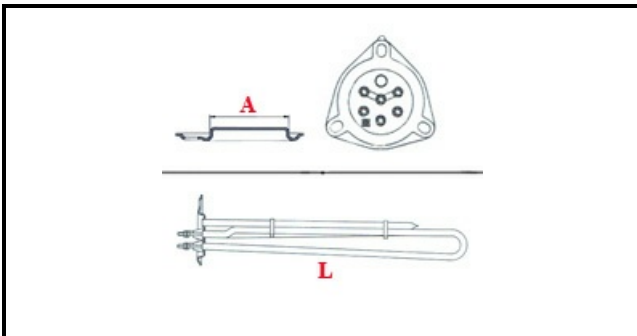

LUNGHEZZA MM	L=485mm
NR ELEMENTI	ELEMENTI/ELEMENTS=3
FLANGIA TRIANGOLARE	TRIANGOLARE/TRIANGULAR FLANGE=57mm
DIAMETRO mm	A=57mm
KILOWATT KW	KW=6
WATT	WATT=6000
TRIFASE	TRIFASE/THREEPHASE
NUMERO POLI	POLI/POLES=6
FORI NUMERO	FORI/HOLES=3
GUARNIZIONE	2101033
RESISTENZE PER IMMERSIONE	IMMERSIONE/IMMERSION

Codici produttore

ANGELO PO GRANDI CUCINE SPA