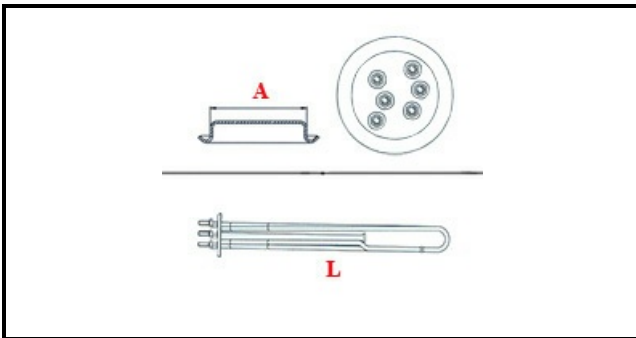

1101541

RESISTENZA BOILER KW 6

Data: 21-11-2024

ORIGINAL
OSP
SPARE PARTS**Dati tecnici**

LUNGHEZZA MM	L=355mm
NR ELEMENTI	ELEMENTI/ELEMENTS=3
FLANGIA TONDA	TONDA/ROUND FLANGE=47mm
DIAMETRO mm	A=47mm
KILOWATT KW	KW=6
WATT	WATT=6000
TRIFASE	TRIFASE/THREEPHASE
NUMERO POLI	POLI/POLES=6
GUARNIZIONE	2101032
RESISTENZE PER IMMERSIONE	IMMERSIONE/IMMERSION

Codici produttore

ANGELO PO GRANDI CUCINE SPA

UNIVERBAR SRL A SOCIO UNICO