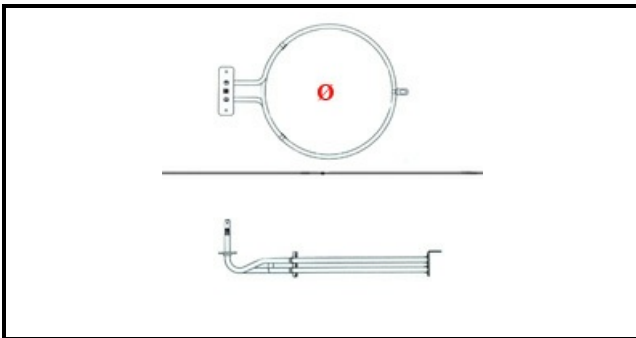

1101658

RESISTENZA FORNO 3000W 230V

Data: 14-03-2025

ORIGINAL
OSP
SPARE PARTS**Dati tecnici**

LUNGHEZZA MM	L=245mm
NR ELEMENTI	ELEMENTI/ELEMENTS=1
FLANGIA RETTANGOLARE/QUADRA	RETTANGOLARE/SQUARE FLANGE=70X22mm
DIAMETRO ESTERNO mm	Ø=190mm
KILOWATT KW	KW=3
WATT	WATT=3000
MONOFASE	MONOFASE/MONOPHASE
NUMERO POLI	POLI/POLES=2
FORI NUMERO	FORI/HOLES=2
RESISTENZE A SECCO	SECCO/DRY
DIAMETRO INTERNO mm	Ø=179mm

Codici produttore

ELECTROLUX PROFESSIONAL S.P.A.

E.G.O. ELEKTRO GERATE AG