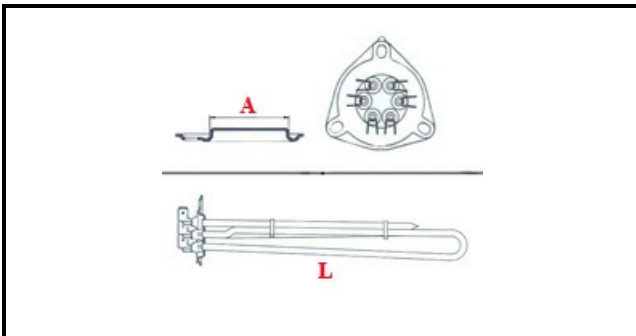

1101787

"RESISTENZA; 230V 9000W"

Data: 14-11-2024

ORIGINAL
OSP
SPARE PARTS**Dati tecnici**

LUNGHEZZA MM	L=330mm
NR ELEMENTI	ELEMENTI/ELEMENTS=3
FLANGIA TRIANGOLARE	TRIANGOLARE/TRIANGULAR FLANGE=57mm
DIAMETRO mm	A=57mm
KILOWATT KW	KW=9
WATT	WATT=9000
TRIFASE	TRIFSAE/THREEPHASE
NUMERO POLI	POLI/POLES=6
FORI NUMERO	FORI/HOLES=3
GUARNIZIONE	2101033
RESISTENZE PER IMMERSIONE	IMMERSIONE/IMMERSION

Codici produttore

ELECTROLUX PROFESSIONAL S.P.A.

ELECTROLUX PROFESSIONAL S.P.A.

ELECTROLUX PROFESSIONAL S.P.A.