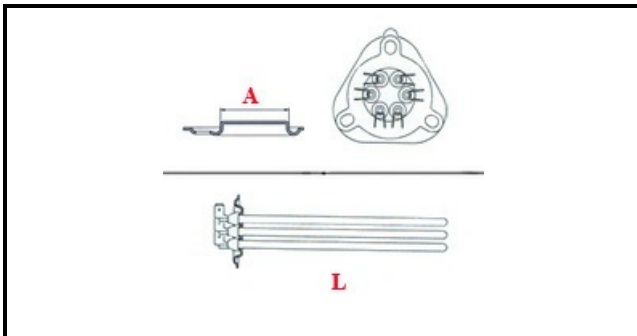

1101423

RESISTENZA BOILER; 4500W 230V

Data: 05-02-2025

ORIGINAL
OSP
SPARE PARTS**Dati tecnici**

| | |
|---------------------------|---------------------------------------|
| LUNGHEZZA MM | L=225mm |
| NR ELEMENTI | ELEMENTI/ELEMENTS=3 |
| FLANGIA TRIANGOLARE | TRIANGOLARE/TRIANGULAR FLANGE=47mm |
| DIAMETRO mm | A=47mm |
| KILOWATT KW | KW=4,5 |
| WATT | WATT=4500 |
| TRIFASE | TRIFASE/THREEPHASE |
| NUMERO POLI | POLI/POLES=6 |
| FORI NUMERO | FORI/HOLES=3 |
| GUARNIZIONE | 2101032 |
| RESISTENZE PER IMMERSIONE | IMMERSIONE/IMMERSION |

Codici produttore

ELECTROLUX PROFESSIONAL S.P.A.