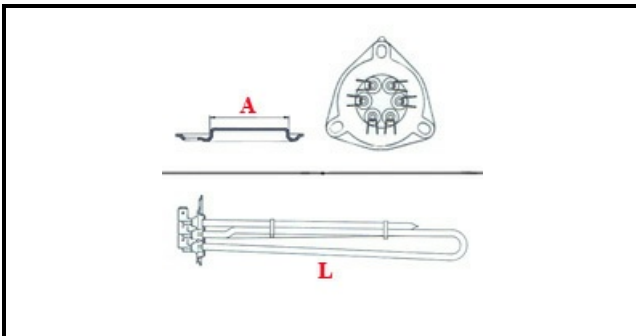

1101940

**"RESISTENZA; 230V 6000W"**

Data: 23-11-2024

ORIGINAL  
**OSP**  
SPARE PARTS**Dati tecnici**

LUNGHEZZA MM	L=337mm
NR ELEMENTI	ELEMENTI/ELEMENTS=3
FLANGIA TRIANGOLARE	TRIANGOLARE/TRIANGULAR FLANGE=57mm
DIAMETRO mm	A=57mm
KILOWATT KW	KW=6
WATT	WATT=6000
TRIFASE	TRIFASE/THREEPHASE
NUMERO POLI	POLI/POLES=6
FORI NUMERO	FORI/HOLES=3
GUARNIZIONE	2101033
RESISTENZE PER IMMERSIONE	IMMERSIONE/IMMERSION

**Codici produttore**

ELECTROLUX PROFESSIONAL S.P.A.

ELECTROLUX PROFESSIONAL S.P.A.