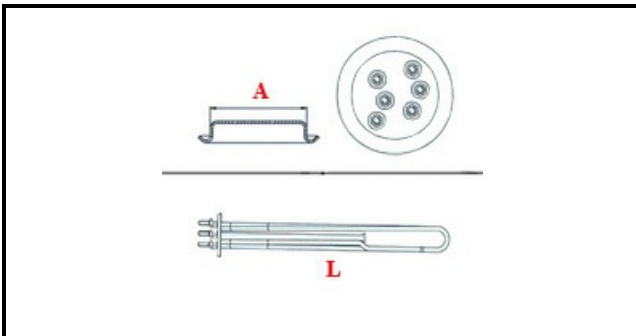

1201002

**Z241701000 RESISTENCIA CALDERIN COMP**

Data: 22-11-2024

**ORIGINAL  
OSP  
SPARE PARTS****Dati tecnici**

LUNGHEZZA MM	L=425mm
NR ELEMENTI	ELEMENTI/ELEMENTS=3
FLANGIA TONDA	TONDA/ROUND FLANGE=63mm
INTERASSE mm	INTERASSE/INTERAX=82mm
DIAMETRO mm	A=63mm
KILOWATT KW	KW=6
WATT	W=6000
TRIFASE	TRIFASE/THREEPHASE
NUMERO POLI	POLI/POLES=6
FORI NUMERO	FORI/HOLES=6
GUARNIZIONE	2101783
RESISTENZE PER IMMERSIONE	IMMERSIONE/IMMERSION
DIAMETRO ESTERNO mm	Ø=98mm

**Codici produttore**

FAGOR INDUSTRIALE S.R.L.

FAGOR INDUSTRIALE S.R.L.