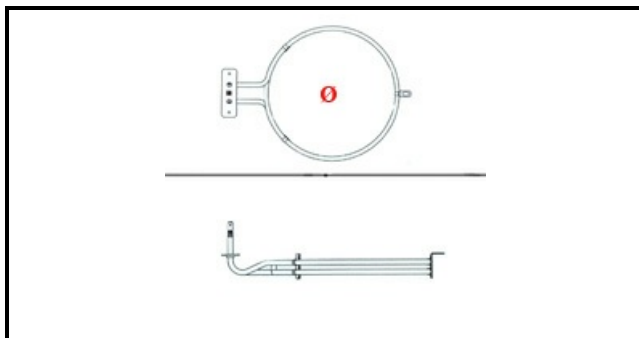

1101192

**RESISTENZA 2500W 240V D. 190**

Data: 23-11-2024

**Dati tecnici**

LUNGHEZZA MM	L=210mm
ALTEZZA MM	H=27mm
NR ELEMENTI	ELEMENTI/ELEMENTS=1
FLANGIA RETTANGOLARE/QUADRA	RETTANGOLARE/SQUARE FLANGE=100X22mm
DIAMETRO ESTERNO mm	Ø=190mm
KILOWATT KW	KW=2,5
WATT	WATT=2500
MONOFASE	MONOFASE/MONOPHASE
NUMERO POLI	POLI/POLES=2
RESISTENZE A SECCO	SECCO/DRY
DIAMETRO INTERNO mm	Ø=176mm

**Codici produttore**

BERTO'S SPA
ELECTROLUX PROFESSIONAL S.P.A.
MARENO ALI GROUP SRL A SOCIO UNICO
GIGA GRANDI CUCINE SRL