

1201064

HEATING ELEMENT

Data: 05-12-2024

ORIGINAL
OSP
SPARE PARTS

Dati tecnici

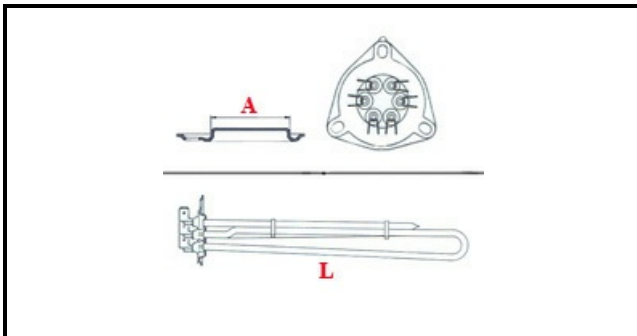

LUNGHEZZA MM	L=350mm
LARGHEZZA MM	A=47mm
NR ELEMENTI	ELEMENTI/ELEMENTS=3
FLANGIA TRIANGOLARE	TRIANGOLARE/TRIANGULAR FLANGE=47mm
DIAMETRO mm	A=47mm
KILOWATT KW	KW=7,26
WATT	WATT=7260
TRIFASE	TRIFASE/GTHREEPHASE
NUMERO POLI	POLI/POLES=6
FORI NUMERO	FORI/HOLES=3
GUARNIZIONE	2101032
RESISTENZE PER IMMERSIONE	IMMERSIONE/IMMERSION

Codici produttore

HOBART GmbH