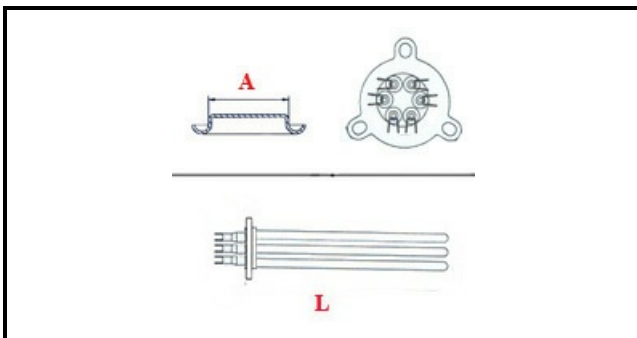

1101170

**RESISTENZA 4000W 230V 2BAR (TN) R01**

Data: 23-11-2024

ORIGINAL  
**OSP**  
SPARE PARTS**Dati tecnici**

LUNGHEZZA MM	L=300mm
NR ELEMENTI	ELEMENTI/ELEMENTS=3
FLANGIA TRIANGOLARE	TRIANGOLARE/TRIANGULAR FLANGE=39mm
DIAMETRO mm	A=39mm
KILOWATT KW	KW=4
WATT	WATT=4000
TRIFASE	TRIFASE/THREEPHASE
NUMERO POLI	POLI/POLES=6
FORI NUMERO	FORI/HOLES=3
RESISTENZE PER IMMERSIONE	IMMERSIONE/IMMERSION

**Codici produttore**

LA PAVONI SPA

LA PAVONI SPA